

SHAPE
BRIGHT
POSITION

SWITCHED
MULT

DYNAMO

3PT

CELLZ

CHIPZ

VCO1

VCO2

VCO3

UCA 1&2

DSP

ROTATING
CLOCK
DIVIDER
PCD

CARA
MARBLES

ADDAZ
104

MM1
FILTER

TYPHOON

MATHS

OBCHD

WRINKS

ALT

TOM BOP-BOP BOP
 'TINK, TINK'
 'MELODY'
 'DA-DA DA'

KICK
 HI HAT
 CLAP
 TOM 1
 TOM 2
 CHIRP

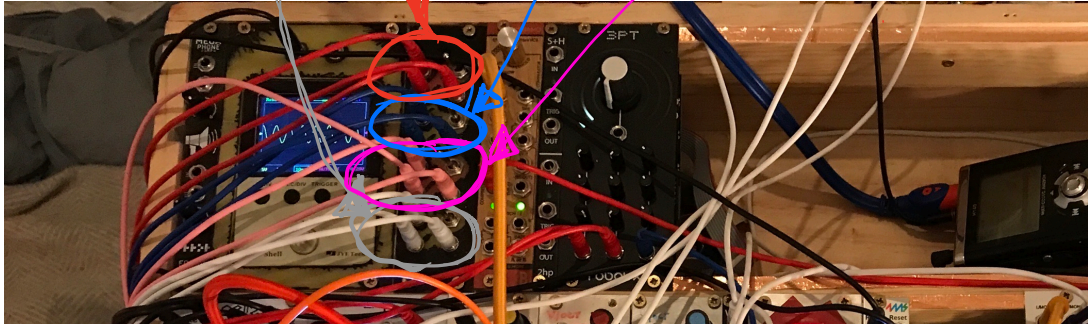

SETTINGS



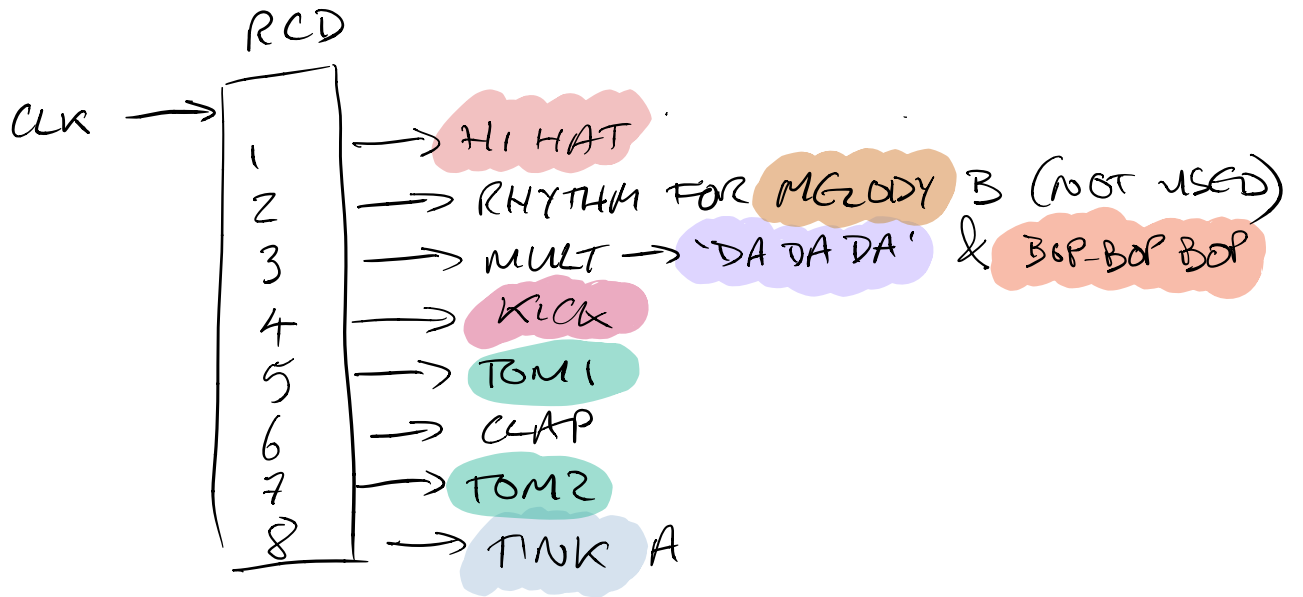

TOMS

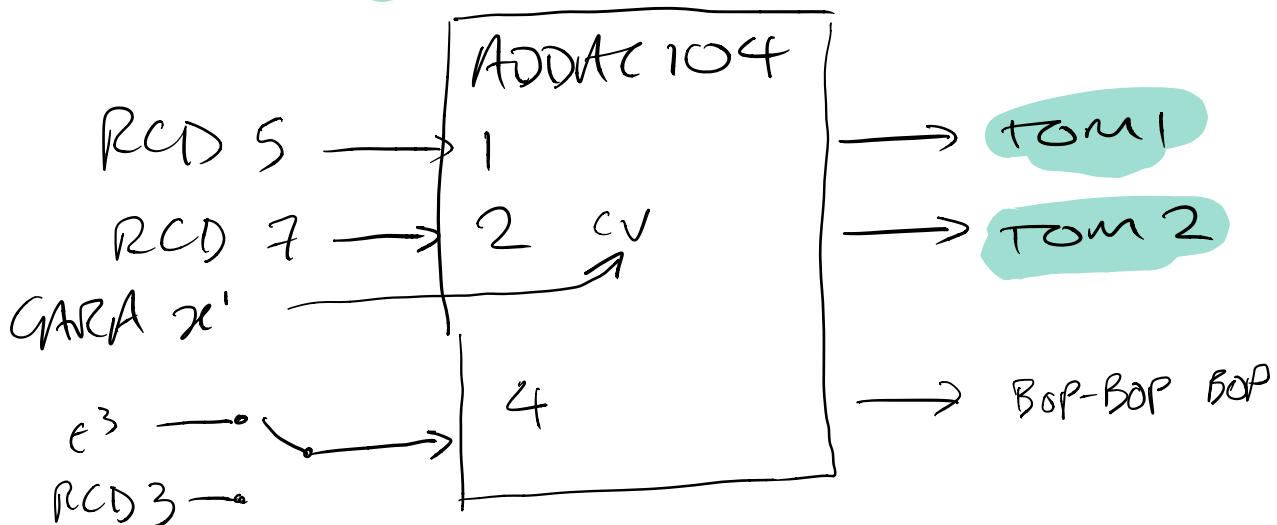

DADRODA

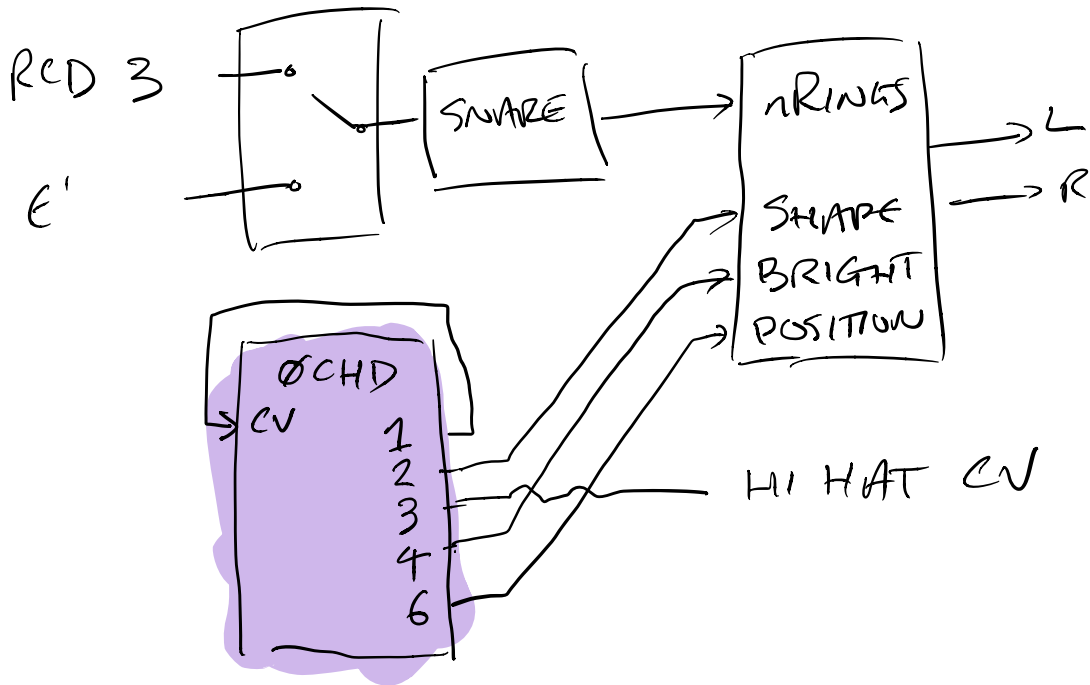

KICK & MIX

FEEDBACK REVERB

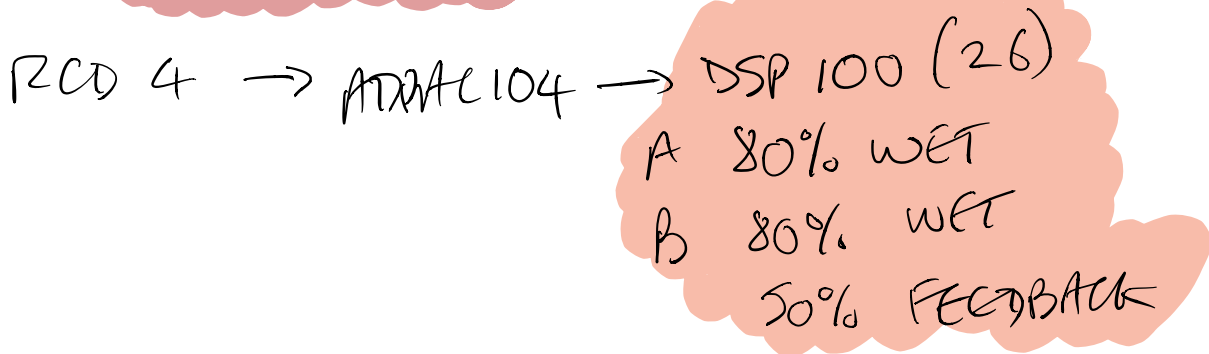

SIDECHAINING BIT

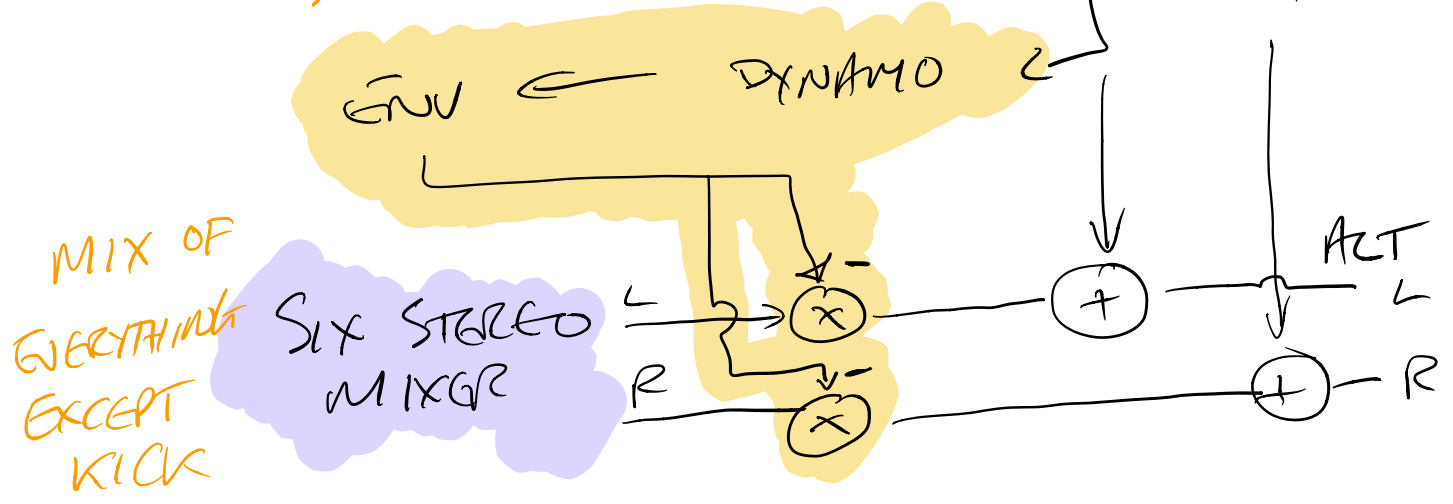

MELODY

TYPHOON WITH FROZEN SAMPLE OF CHIP 7
AS VOICE + MIX OF OSC 3 INPUT

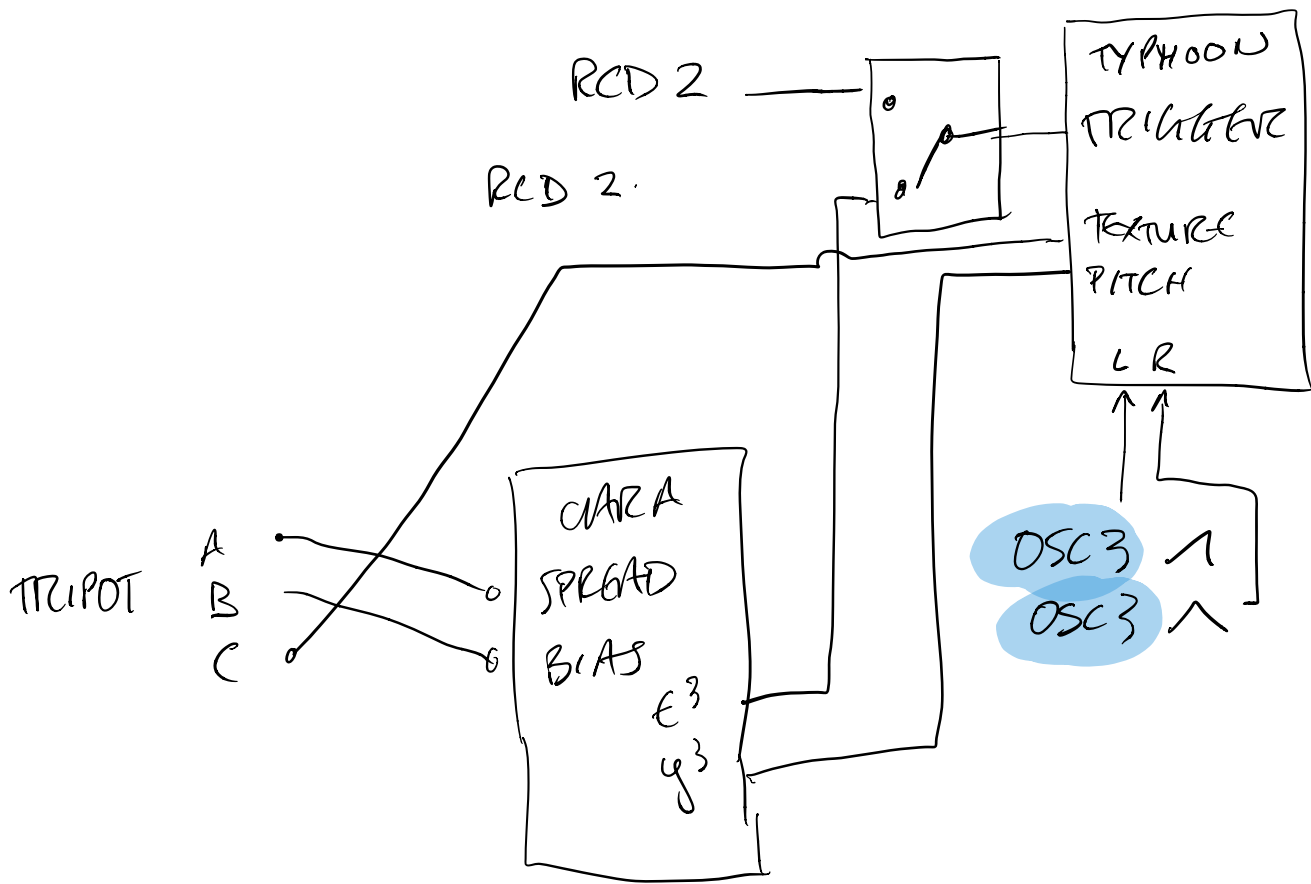

MULTS

- E3 → MELODY
- BOP-BOP BOP
- TINK

RCD 3 → DA DA DA

- BOP-BOP BOP

TRNK

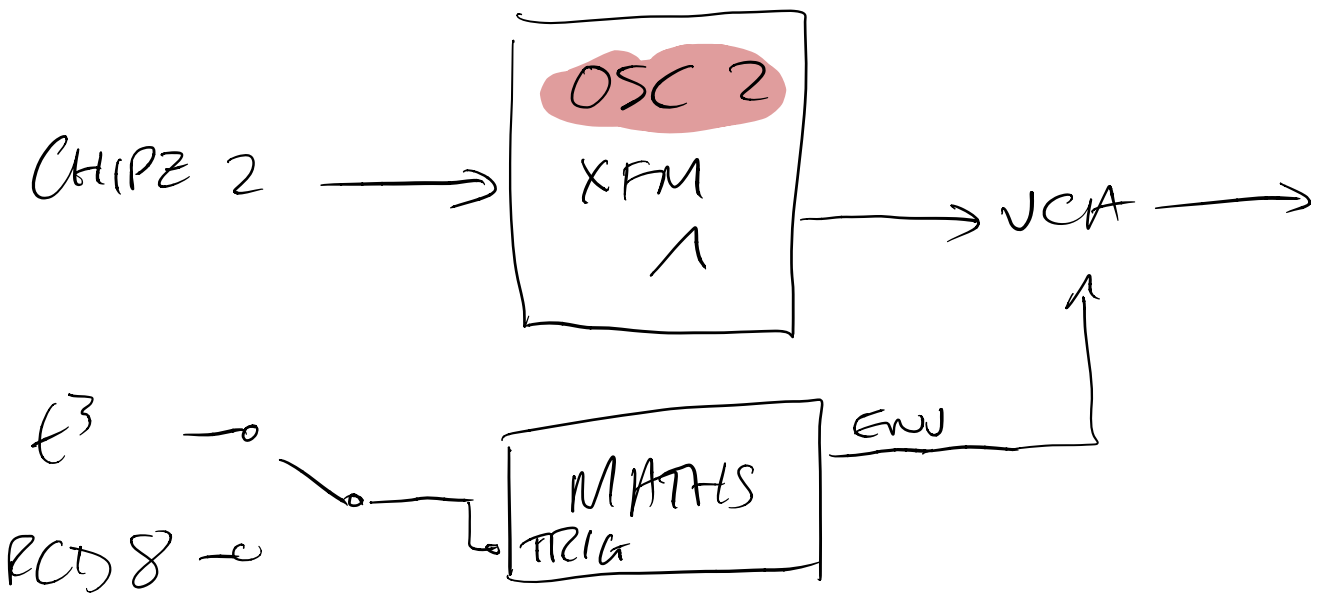

DRONE

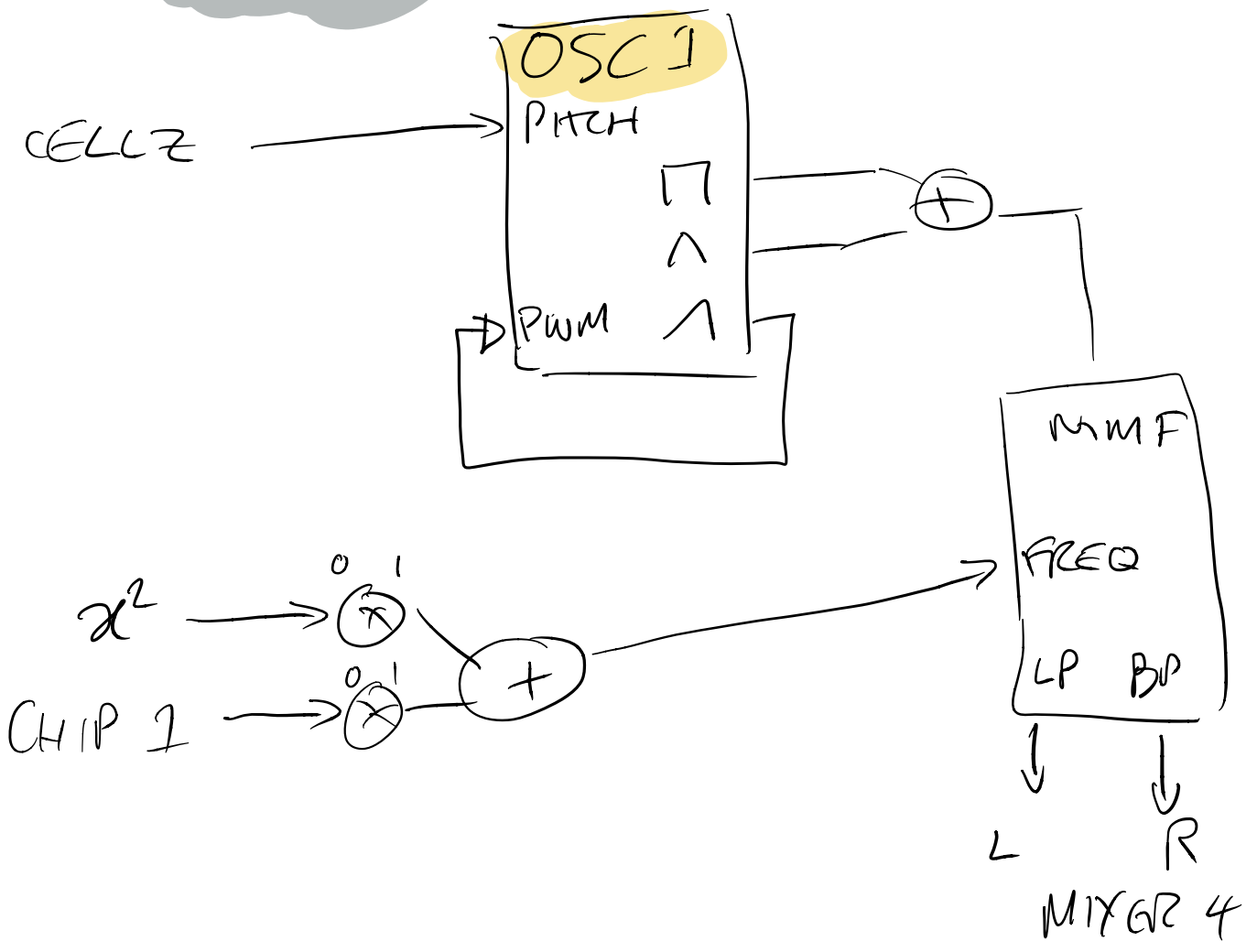

ONIRP

ADDA10Z
MIX



TYPHOON
TYPHOON